

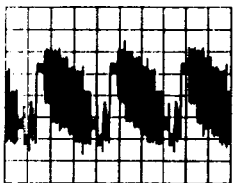



# WAVE FORMS



① 2.2 Vp-p (H)

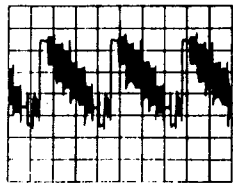

② 1.0 Vp-p (H)

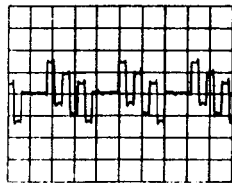

③ 1.3 Vp-p (H)

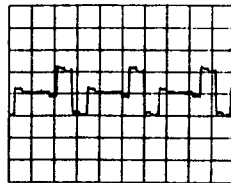

④ 1.0 Vp-p (H)

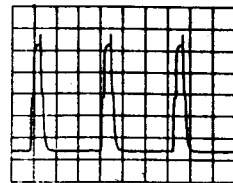

⑤ 5.0 Vp-p (H)

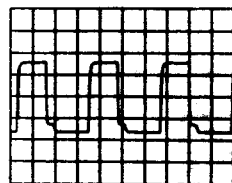

⑥ 3.2 Vp-p (H)

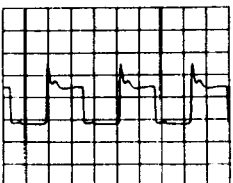

⑦ 140 Vp-p (H)

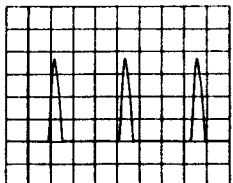

⑧ 925 Vp-p (H)

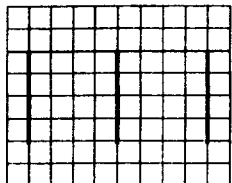

⑨ 4.1 Vp-p (V)

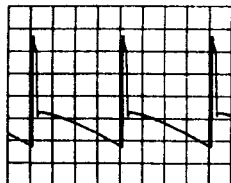

⑩ 50 Vp-p (V)

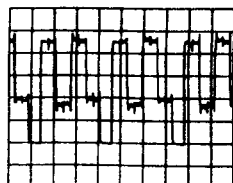

⑪ 4.5 Vp-p (H)

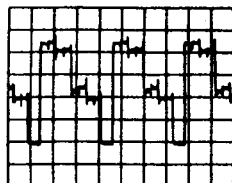

⑫ 4.5 Vp-p (H)



⑬ 4.5 Vp-p (H)

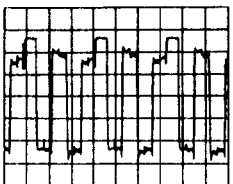

⑭ 100 Vp-p (H)

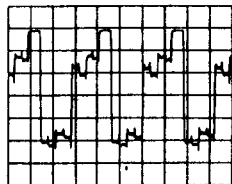

⑮ 100 Vp-p (H)

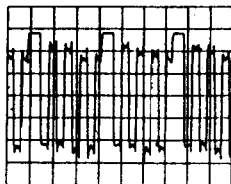

⑯ 100 Vp-p (H)

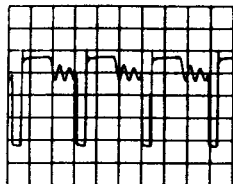

⑰ 440 Vp-p



# PWB-C (CRT UNIT) DUNTK8598WEV1

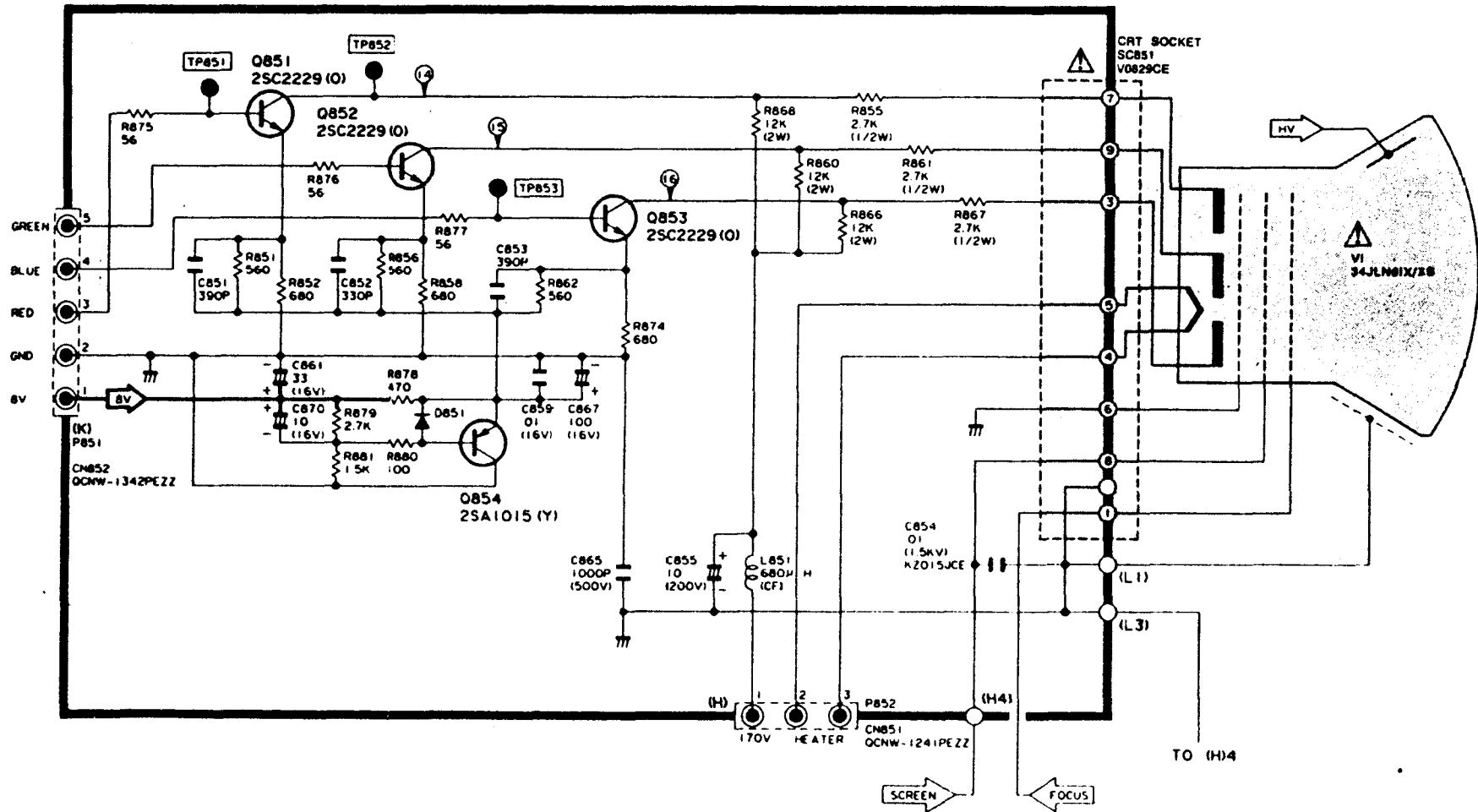

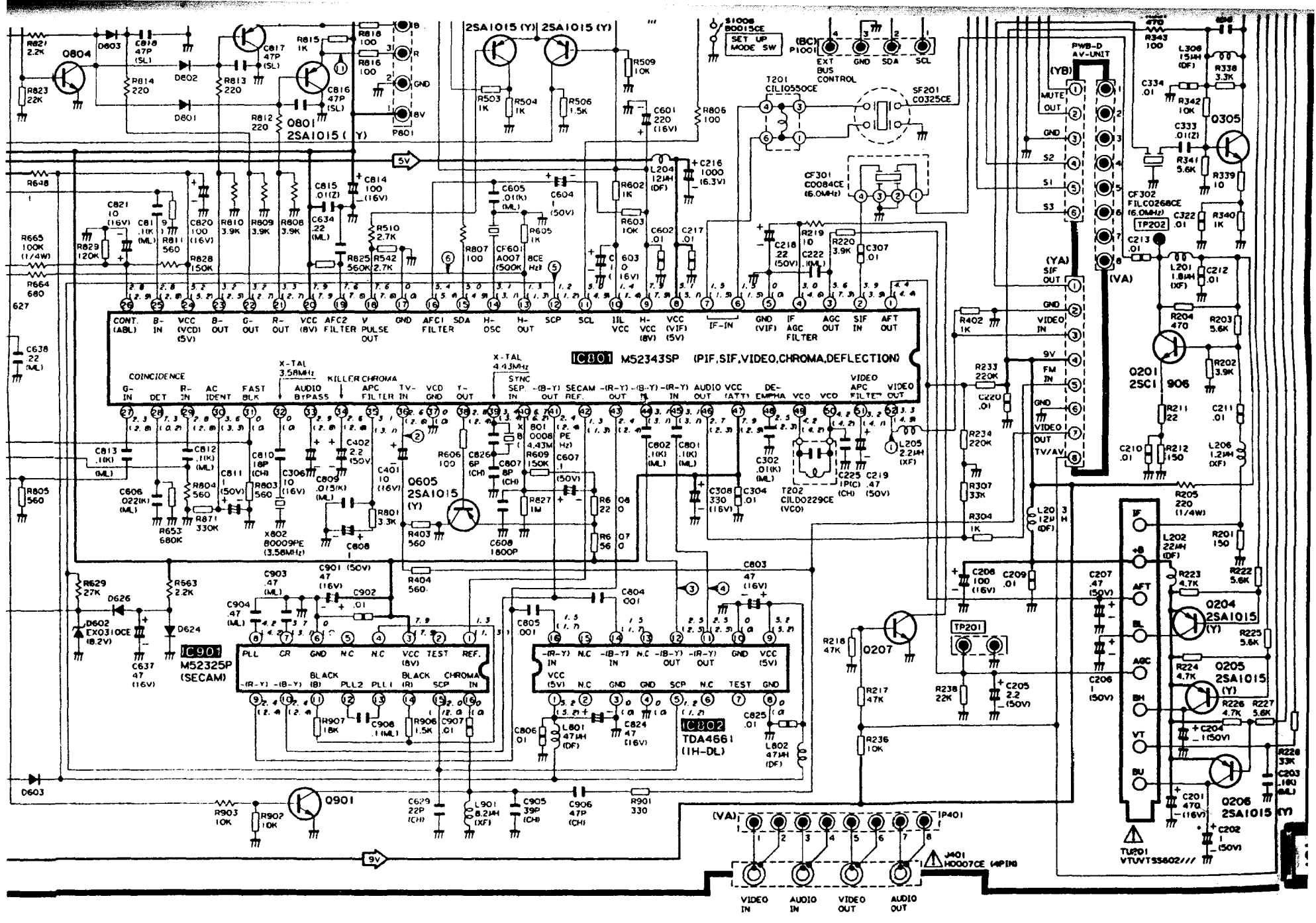



# CHASSIS LAYOUT

