

1 2 3 4 5 6

A

B

C

D



E

F

G

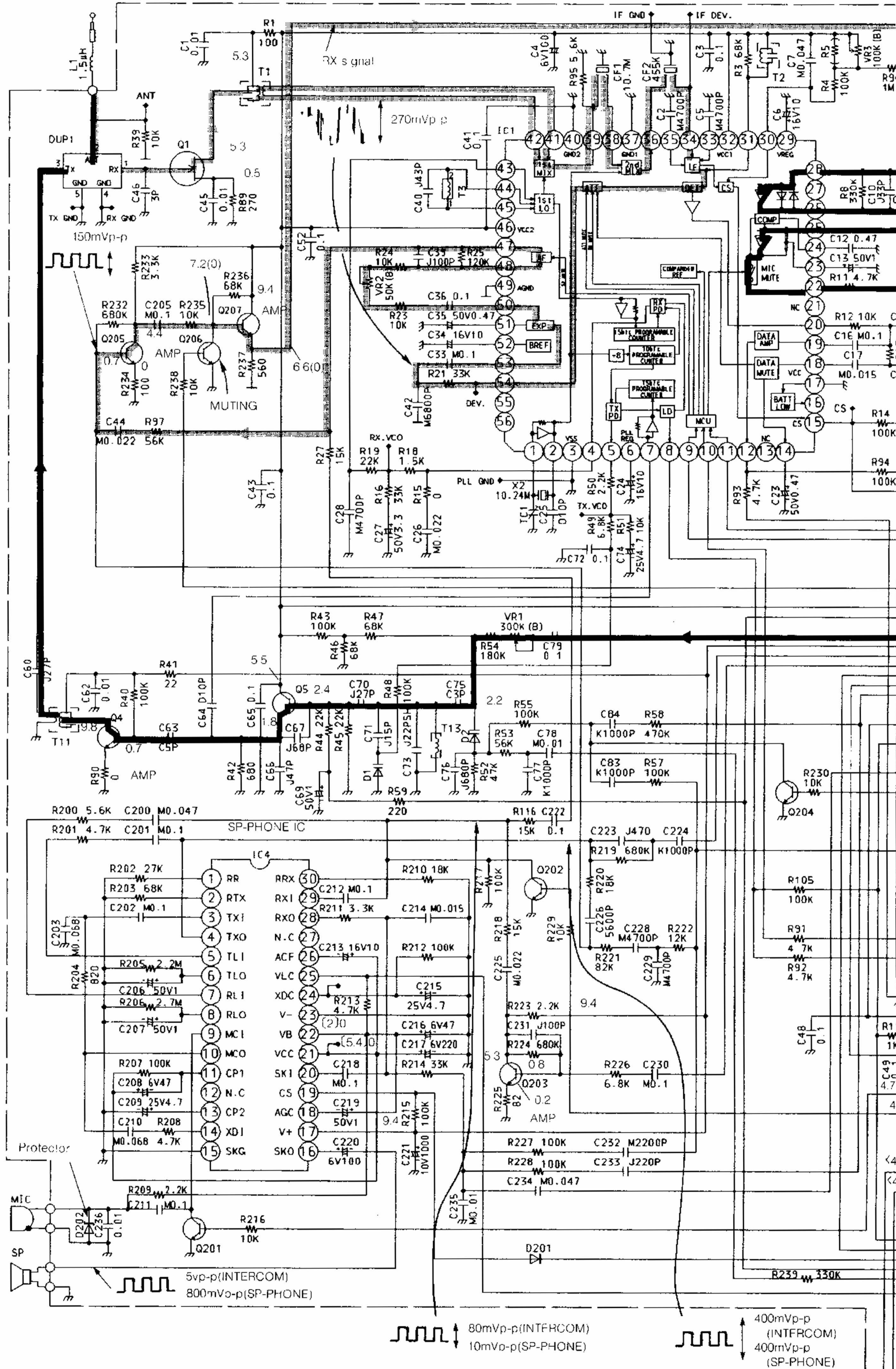
H

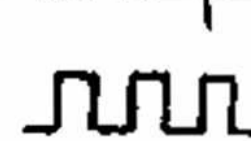
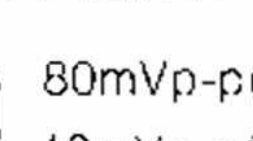
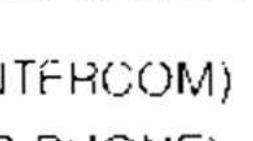

 80mVp-p (INTERCOM)
 10mVp-p (SP-PHONE)
 400mVp-p (INTERCOM)
 400mVp-p (SP-PHONE)

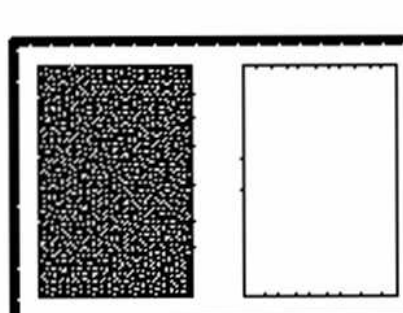

WIRING DIAGRAM (KX-T3967H-B)

7

8

9

10

11

12

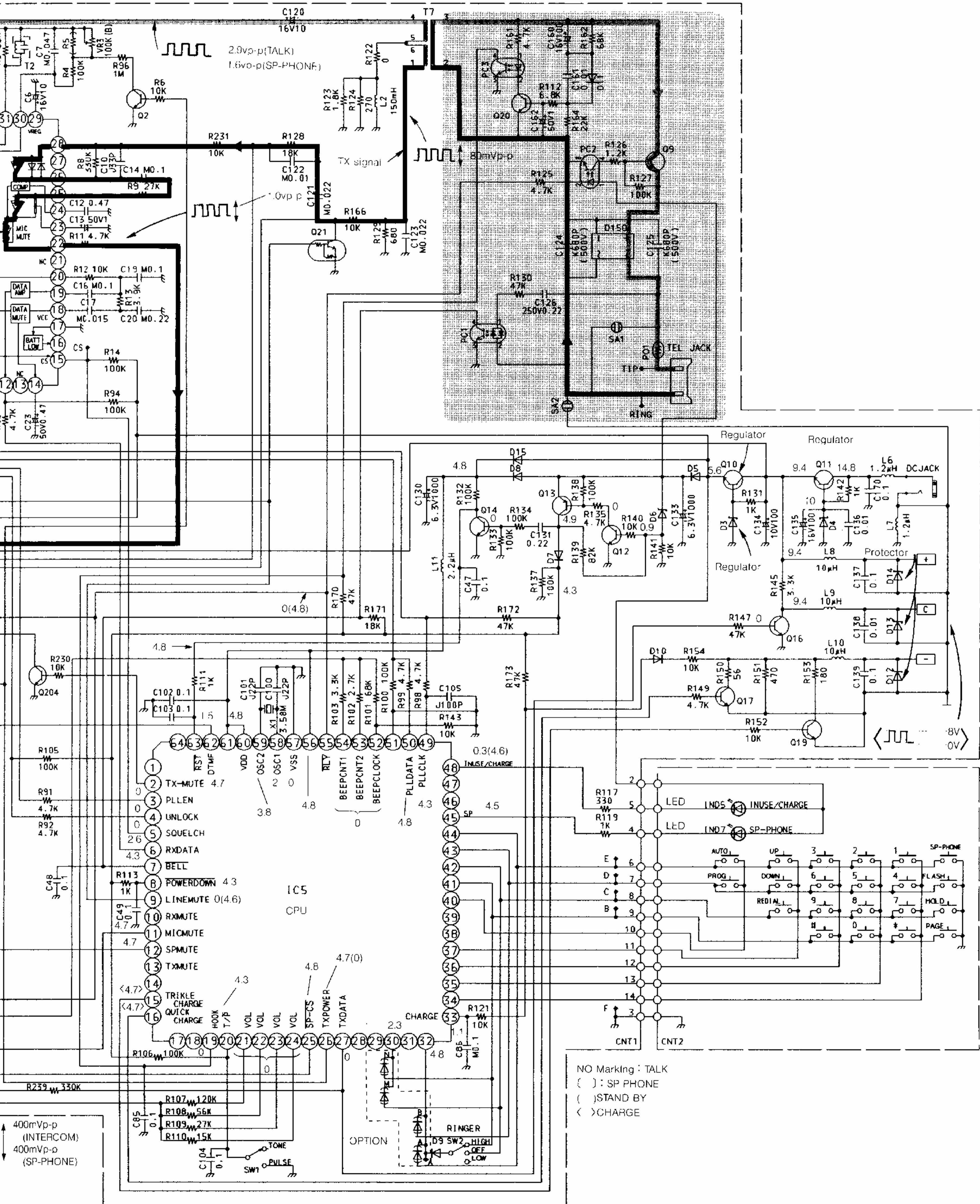

NO Marking : TALK
 () : SP PHONE
 () : STAND BY
 < > : CHARGE

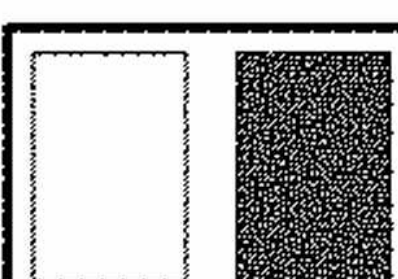

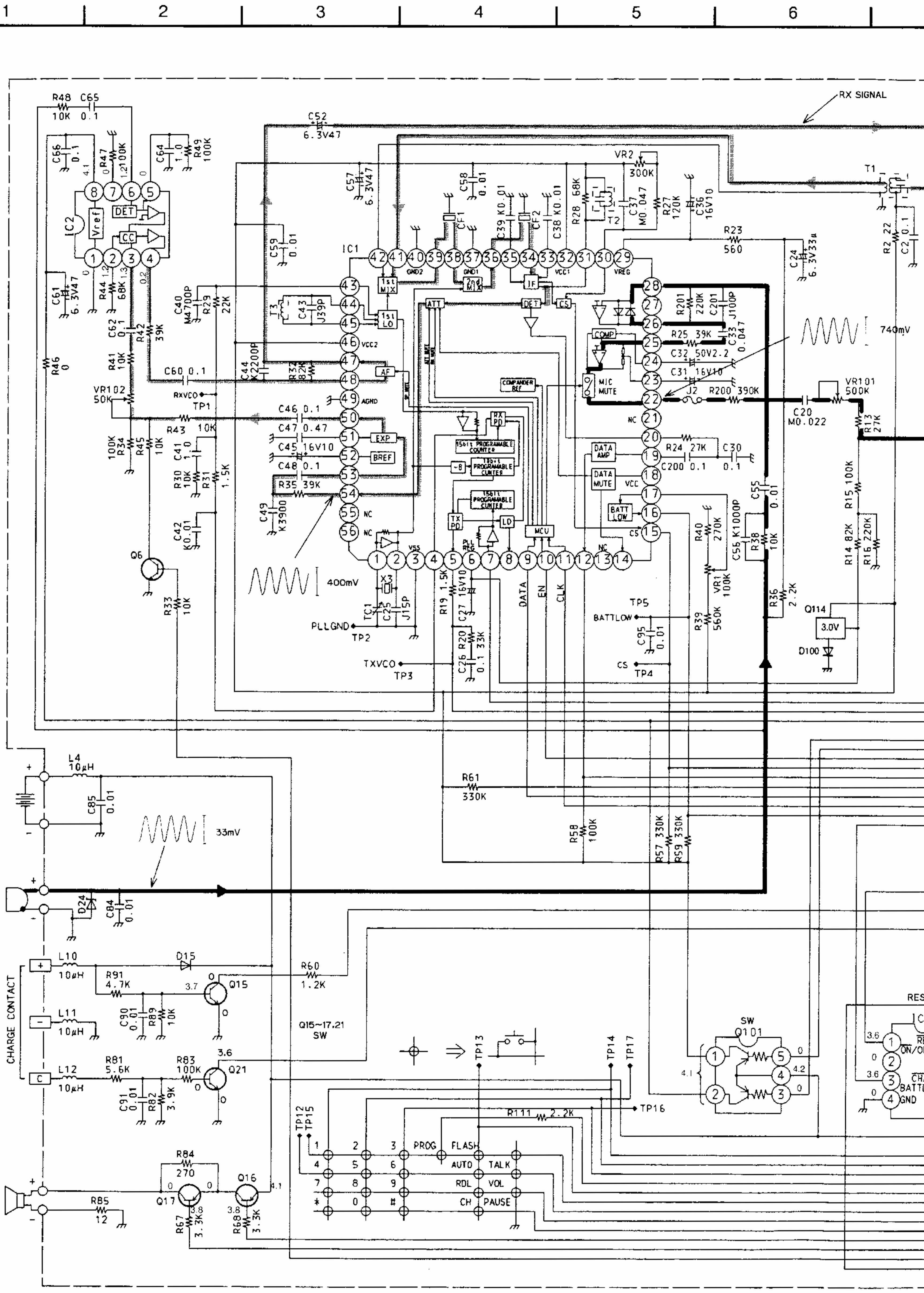

A
B
C
D
E
F
G
H
I

1 2 3 4 5 6

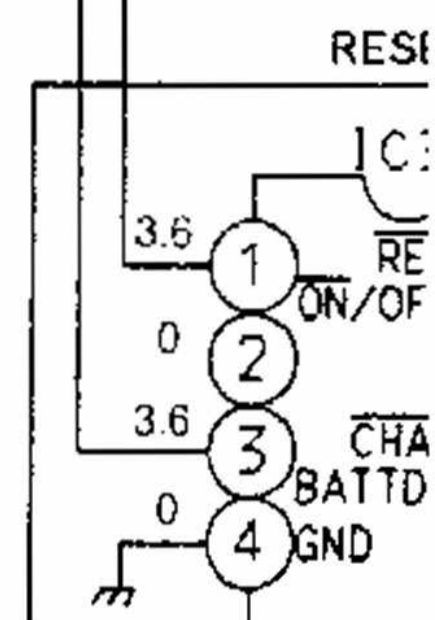

RESI
3.6
1
RE
ON/OFF
3.6
2
CHA
BATTD
4.2
3
0
4
GND

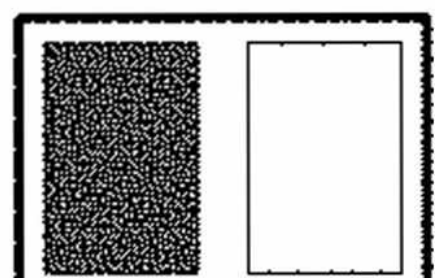

SCHEMATIC DIAGRAM (KX-T3967R-B)

6

7

8

9

10

11

1

